

UK-S 42400

Standard Arm Installations Dimensions

Regular Arm Installation – Fig. 1

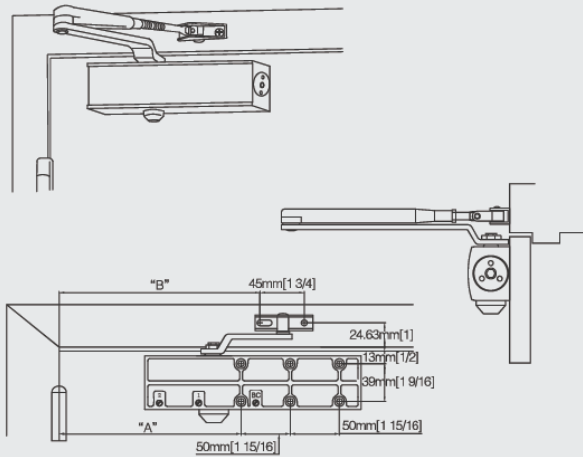

OPENING	DIM. "A" CLOSER		DIM. "B" CLOSER	
	INCHES	MM	INCHES	MM
120	8 1/4	210	8 1/4	210
180	7 5/16	185	8 1/4	210

Parallel Arm Installation – Fig. 66

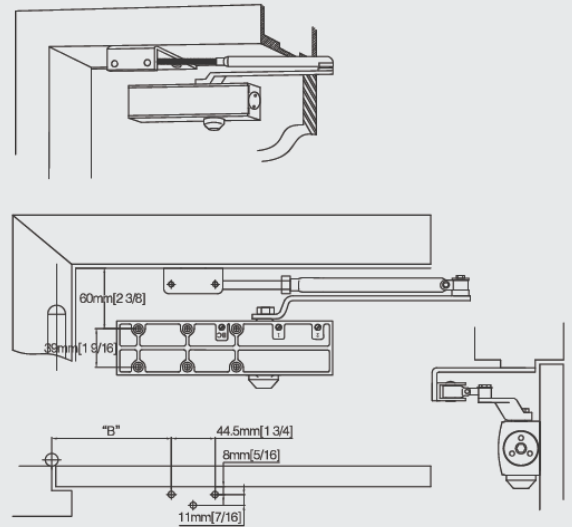

OPENING	DIM. "A" CLOSER		DIM. "B" CLOSER	
	INCHES	MM	INCHES	MM
180	5	127	8 1/4	210

Top Jamb Installation – Fig. 61

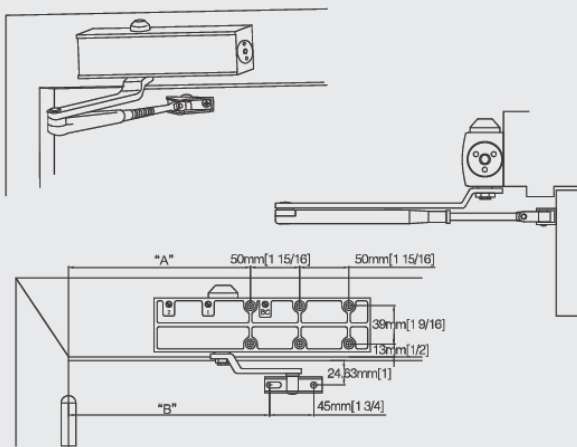

OPENING	DIM. "A" CLOSER		DIM. "B" CLOSER	
	INCHES	MM	INCHES	MM
120	8 1/4	210	8 1/4	210
180	7 5/16	185	8 1/4	210

Special Cautions

1. Please read the installation instructions carefully before beginning the installation.
2. Door can be closed automatically under the door closer pressure and no extra force need to be exerted, or it can cause the failure of the product.
3. In the case of unusually high or heavy doors, windy or draughty conditions, or special installations, a large power size of door closer should be used.
4. DO NOT adjust the valve out of closer body, or it may cause leaking & final failure of the product.